

**ASUS<sup>®</sup>**

# **Xonar U1**

*External USB Audio Station*

## **User's manual**

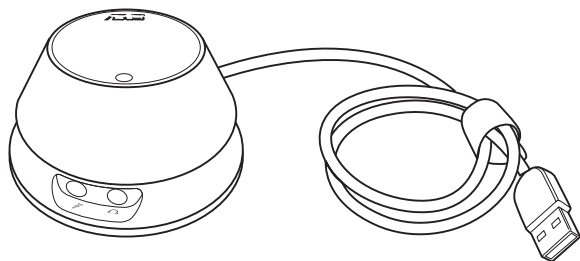

E3348

First Edition V1  
September 2007

**Copyright © 2007 ASUSTeK COMPUTER INC. All Rights Reserved.**

No part of this manual, including the products and software described in it, may be reproduced, transmitted, transcribed, stored in a retrieval system, or translated into any language in any form or by any means, except documentation kept by the purchaser for backup purposes, without the express written permission of ASUSTeK COMPUTER INC. ("ASUS").

Product warranty or service will not be extended if: (1) the product is repaired, modified or altered, unless such repair, modification or alteration is authorized in writing by ASUS; or (2) the serial number of the product is defaced or missing.

ASUS PROVIDES THIS MANUAL "AS IS" WITHOUT WARRANTY OF ANY KIND, EITHER EXPRESS OR IMPLIED, INCLUDING BUT NOT LIMITED TO THE IMPLIED WARRANTIES OR CONDITIONS OF MERCHANTABILITY OR FITNESS FOR A PARTICULAR PURPOSE. IN NO EVENT SHALL ASUS, ITS DIRECTORS, OFFICERS, EMPLOYEES OR AGENTS BE LIABLE FOR ANY INDIRECT, SPECIAL, INCIDENTAL, OR CONSEQUENTIAL DAMAGES (INCLUDING DAMAGES FOR LOSS OF PROFITS, LOSS OF BUSINESS, LOSS OF USE OR DATA, INTERRUPTION OF BUSINESS AND THE LIKE), EVEN IF ASUS HAS BEEN ADVISED OF THE POSSIBILITY OF SUCH DAMAGES ARISING FROM ANY DEFECT OR ERROR IN THIS MANUAL OR PRODUCT.

SPECIFICATIONS AND INFORMATION CONTAINED IN THIS MANUAL ARE FURNISHED FOR INFORMATIONAL USE ONLY, AND ARE SUBJECT TO CHANGE AT ANY TIME WITHOUT NOTICE, AND SHOULD NOT BE CONSTRUED AS A COMMITMENT BY ASUS. ASUS ASSUMES NO RESPONSIBILITY OR LIABILITY FOR ANY ERRORS OR INACCURACIES THAT MAY APPEAR IN THIS MANUAL, INCLUDING THE PRODUCTS AND SOFTWARE DESCRIBED IN IT.

Products and corporate names appearing in this manual may or may not be registered trademarks or copyrights of their respective companies, and are used only for identification or explanation and to the owners' benefit, without intent to infringe.

# Contents

Contents .....	iii
Notices .....	v
Safety information .....	vi
Trademarks.....	vi
License .....	vi
<b>1. Introduction .....</b>	<b>1</b>
1.1 Package Contents.....	1
1.2 System Requirements.....	1
1.3 Specifications summary .....	2
<b>2. About Hardware .....</b>	<b>4</b>
2.1 Xonar U1 Audio Station.....	4
<b>3. Installing the Xonar Hardware .....</b>	<b>5</b>
3.1 Installing Xonar U1 .....	5
<b>4. Installing Software .....</b>	<b>6</b>
4.1 Installing the Audio Station Driver .....	6
4.2 Installing the PMP Lite software (Portable Music Processor™ Lite) .....	7
4.3 Uninstalling or Reinstalling Software .....	7
<b>5. Connecting Speakers and Peripherals .....</b>	<b>9</b>
5.1 Connecting Digital Speaker Systems (Home Theater) .....	9
5.2 Connecting Headphones .....	10
5.3 Connecting Microphone .....	11
5.4 Connecting Line-In Audio Sources.....	11
<b>6. Xonar U1 Driver Guide.....</b>	<b>12</b>
6.1 Introduction to the Xonar U1 Audio Center GUI.....	12
6.2 Main Setting .....	14
6.3 Mixer/Volume .....	22
6.4 Effects .....	25
6.5 Karaoke/Magic Voice .....	27
6.6 Mic Array .....	28
6.7 Smart Volume Normalization .....	29
6.8 DSP Modes .....	31

# Contents

<b>7.</b>	<b>Portable Music Processor™ Lite Software Guide.....</b>	<b>32</b>
7.1	Introduction .....	32
7.2	Converting music in “Main Setting” Page.....	34
7.3	Find Converted Music in “PMP Music” Page .....	36
<b>8.</b>	<b>Troubleshooting and FAQs .....</b>	<b>37</b>

# Notices

## Federal Communications Commission Statement

This device complies with Part 15 of the FCC Rules. Operation is subject to the following two conditions:

- This device may not cause harmful interference, and
- This device must accept any interference received including interference that may cause undesired operation.

This equipment has been tested and found to comply with the limits for a Class B digital device, pursuant to Part 15 of the FCC Rules. These limits are designed to provide reasonable protection against harmful interference in a residential installation. This equipment generates, uses and can radiate radio frequency energy and, if not installed and used in accordance with manufacturer's instructions, may cause harmful interference to radio communications. However, there is no guarantee that interference will not occur in a particular installation. If this equipment does cause harmful interference to radio or television reception, which can be determined by turning the equipment off and on, the user is encouraged to try to correct the interference by one or more of the following measures:

- Reorient or relocate the receiving antenna.
- Increase the separation between the equipment and receiver.
- Connect the equipment to an outlet on a circuit different from that to which the receiver is connected.
- Consult the dealer or an experienced radio/TV technician for help.

## Canadian Department of Communications Statement

This digital apparatus does not exceed the Class B limits for radio noise emissions from digital apparatus set out in the Radio Interference Regulations of the Canadian Department of Communications.

This class B digital apparatus complies with Canadian ICES-003.

## Safety information

- Before installing the device on a motherboard, carefully read all the manuals that came with the package.
- If the device is broken, do not try to fix it by yourself. Contact a qualified service technician or your retailer.
- Before using the product, make sure all cables are correctly connected. If you detect any damage, contact your dealer immediately.
- To avoid short circuits, keep paper clips, screws, and staples away from connectors, sockets and circuitry.
- Avoid dust, humidity, and temperature extremes. Do not place the product in any area where it may become wet.
- Place the product on a stable surface.
- If you encounter technical problems with the product, contact a qualified service technician or your retailer.



---

This symbol of the crossed out wheeled bin indicates that the product (electrical, electronic equipment and mercury-containing button cell battery ) should not be placed in municipal waste. Check local regulations for disposal of electronic products.

---

## Trademarks

Xonar and ASUS logo are trademarks of ASUSTek Computer Inc. “Dolby” and “Dolby Digital Live”, “Dolby Pro Logic IIx”, “Dolby Virtual Speaker”, “Dolby Headphone” are trademarks of Dolby Laboratories. EAX and A3D are trademarks of Creative Technology Ltd. Microsoft, DirectSound3D, Windows are trademarks of Microsoft Corporation. Other company and product names may be trademarks of the respective companies with which they are associated. ASIO is a trademark and software of Steinberg Media Technologies GmbH.

## License

Dolby Master Studio driver is manufactured under license from Dolby Laboratories.

# **1. Introduction**

## **1.1 Package Contents**

- Xonar™ U1 Audio USB dongle
- Driver Support CD (including Portable Music Processor™ Lite utility)
- S/PDIF TOSLINK optical adaptor \*1
- Array Microphone \*1
- Dolby Demo CD
- Quick Start Guide

## **1.2 System Requirements**

- IBM compatible PC with one USB1.1 (or higher) compatible port for the USB audio device
- Microsoft® Windows® Vista/XP(32/64bit)/MCE2005
- Intel® Pentium®4 1.4GHz or AMD Athlon 1400 CPU or faster CPU
- > 256 MB DRAM system memory
- > 60 MB available HDD space for driver installation package
- CD-ROM drive (or DVD-ROM drive) for software installation
- High-quality headphones, powered analog speakers, or a Dolby Digital decoder, to enjoy the Ultra-High Fidelity sounds of the USB audio device

## 1.3 Specifications summary

Category	Item	Description
Audio Controller and Codec	Audio Chipset	ASUS UA100 USB Audio Chip
Bus Interface	USB Bus	USB 2.0 and 1.0 Full-speed compatible
	USB Audio Class	USB Audio Device Class v1.0 compatible
I/O Ports	Analog Output Jack & Digital S/PDIF Output Combo	3.50mm mini analog and digital combo jack *1 (Headphone/Speakers/SPDIF output)
	Built-in Headphone Amplifier	To drive best listening quality with common stereo headphones (recommended 8~150 ohms @ >10mWx2)  THD+N< 0.005% @ 47mW x2/ 32ohms THD+N< 0.006% @ 88mW x2/16ohms 96dB SNR  >1.1Vrms full-scale output voltage for >8 ohms load  Frequency Response (-3dB/48KHz): 20~20KHz for 32ohms
	Analog Input Jack:	3.50mm mini shared jack *1 (Line-In/Mic-In)
Outlook Features	Volume Knob	Metal and consumer typed rotary volume knob
	Hot Buttons	Mute (short push) and Hi-Fi mode (long push) switch by pushing volume knob
	LED indicator	Red (for mute) and blue (for Hi-Fi mode) LED
Driver Features	Operation System	Windows® Vista/XP(32/64bit)
	Dolby® Technologies	Dolby® Headphone, Dolby® Virtual Speaker, Dolby® Pro-Logic IIx, Dolby® Digital Live
	Smart Volume Normalizer™	Normalizes the volume of all audio sources into a constant level
	Xear 3D™ Virtual Speaker Shifter	Virtual 7.1 speaker positioning
	Magic Voice™	Modifies the sound of your voice, for VOIP and online chat applications (Windows XP)
	Karaoke Functions	Music Key-Shifting and Microphone Echo effects (Windows XP)
	Array Microphone	Suppress the ambient sounds and noises into the microphones for up-to-15dB and delivers only your front-side (+60dB degree) clean voice for better online communication/gaming experience. It can also enhance the accuracy of voice recognition applications.
	Other Effects	10-band Equalizer/27 Environment Effects
	3D Sound Engines/APIs	EAX® 2.0&1.0, A3D® 1.0, DirectSound® HW & SW, OpenAL generic modes
S/PDIF Digital Output	PCM, Dolby Digital, DTS 5.1 Surround	

(Continued on the next page)



<b>Software Utility</b>	Portable Music Processor Lite	Converts digital music content or CD audio into regular MP3/WMA files with Dolby Headphone, Dolby Virtual Speaker (w/ Pro-Logic II), and Smart Volume Normalization processing (Windows Media Player 10 or above is required)
<b>Audio Performance</b>	Output Signal-to-Noise Ratio (silence, A-Weighted):	100dB
	Output Dynamic Range (-60dB, A-Weighted):	96dB
	Cross-talk (10Kohms, 1KHz)	-104dB
	Frequency Response (-1dB, 48KHz):	< 20Hz to 20KHz
	Output/Input Full-Scale Voltage	1.2 Vrms / 1.1 Vrms
<b>Accessories</b>	-S/PDIF optical adaptor *1 -2-channel vertical Array Microphone	

\*Specifications are subject to change without notice.

## 2. About Hardware

### 2.1 Xonar U1 Audio Station

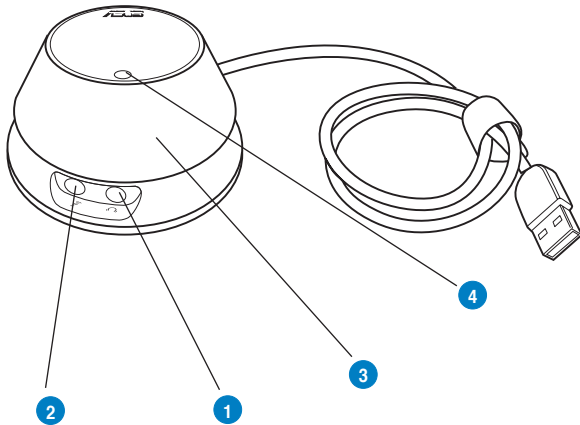

No	Item	Description
1	Microphone Jack	Connect your external PC microphone to this 3.5mm jack for voice input. Built-in high-quality Microphone pre-amplifier.
	Line Input Jack	Connect analog devices like MP3 players, CD players, music synthesizers and other line-level sound sources to this 3.5mm jack for audio recording or processing.
2	Headphone/Front Output Jack	Connect your headphones or 2/2.1 channel speakers to this jack. For multi-channel speaker systems, connects to the front left/right input on the powered speakers.
	S/PDIF Output	Coaxial and optical TOSLINK combo digital output jack. Connects to external digital decoder or digital speaker systems, Home Theater systems, AV receivers for outputting digital audio including PCM, Dolby Digital, DTS, WMA-Pro, etc.
3	Volume Knob	Rotate this knob to adjust the volume
	Hot Button	Short push this knob to mute the music, and long push to turn to the Hi-Fi mode.
4	LED indicator	Red --> mute; blue --> Hi-Fi mode

## 3. Installing the Xonar Hardware

### 3.1 Installing Xonar U1

Connect the USB connector to any USB 2.0 port on your notebook or PC as the following drawing shows.

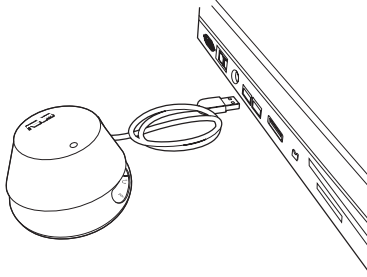

## 4. Installing Software

### 4.1 Installing the Audio Station Driver

1. After you have installed your audio station, turn on your computer. Windows automatically detects your audio station and searches for device drivers. When prompted for the audio drivers, click the “Cancel” button.
2. Insert the driver installation CD into your CD-ROM or DVD-ROM drive. If Windows AutoPlay mode is enabled for your CD-ROM drive, the CD starts running automatically. If it doesn’t start the installation, double-click the setup.exe icon located on the CD-ROM.
3. Follow the instructions on the screen to complete the installation. Please read the “END USER LICENCE AGREEMENT” in the process and make sure you understand and accept it before you continue the installation. When the installation finishes, you may be prompted to restart your computer. You can choose to restart the computer later if desired.



## 4.2 Installing the PMP Lite software (Portable Music Processor™ Lite)

1. From the installation CD menu, select the option to install the PMP Lite software.
2. Follow the instructions on the screen to complete the installation. After the installation is complete, click Finish.

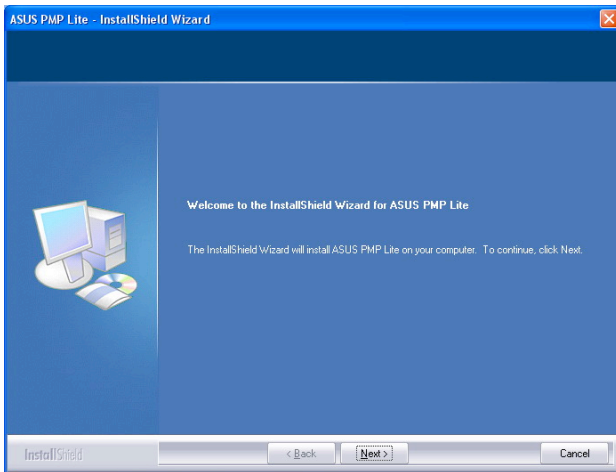

## 4.3 Uninstalling or Reinstalling Software

### 4.3.1 Uninstalling Software

1. Select the corresponding uninstallation program, under the “All Programs” section of the Start menu. Otherwise, you’ll need to use the Windows control panel for uninstallation as follows.

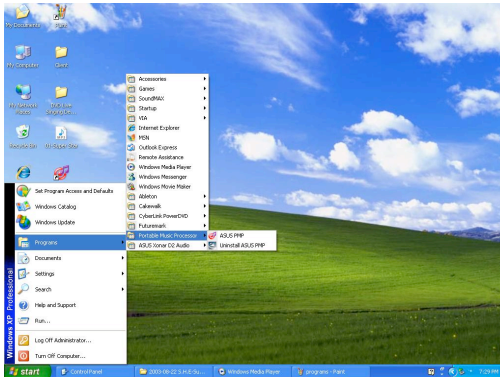

2. Click Start -> Settings -> Control Panel.
3. Double-click the “Add/Remove Programs” icon.
4. Click the “Change or Remove Programs” button.
5. Select each program you would like to remove, and then click the “Add/Remove (or Change/Remove)” button.

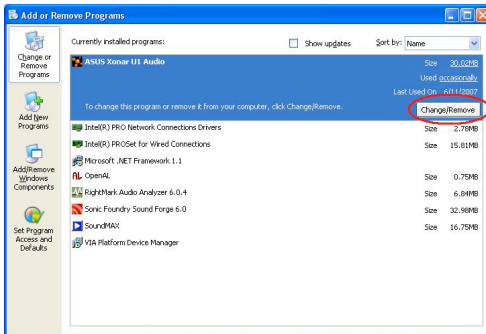

6. In the InstallShield Wizard dialog box, select the “Remove” option.
7. Restart your computer when prompted.

### 4.3.2 Reinstalling Software

1. Before you reinstall any software, it’s recommended to uninstall the existing software first.
2. After you finish the uninstallation of the software, please follow the installation process again to reinstall the same or updated software.

# 5. Connecting Speakers and Peripherals

## 5.1 Connecting Digital Speaker Systems (Home Theater)

The Xonar U1 supports Dolby Digital Live technologies, which transcode any audio, including games and music, into industry-standard Dolby Digital surround bit-streams. This makes playback through your home theater system possible, creating an immersive and impressive cinema surround sound experience. A single digital cable connection can carry high-quality Dolby Digital audio from any of your PC audio sources to any digital speakers or AV Receivers with Dolby Digital decoding capabilities.

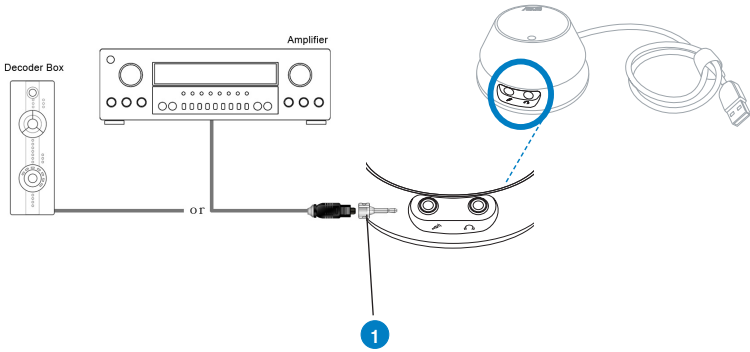

No	Item	Description
1	Optical adaptor	Plug the optical TOSLINK adaptor into the S/PDIF-Out combo connector

## 5.2 Connecting Headphones

### 5.2.1 Connecting 2/2.1 Channel Speakers

#### 2 Speakers

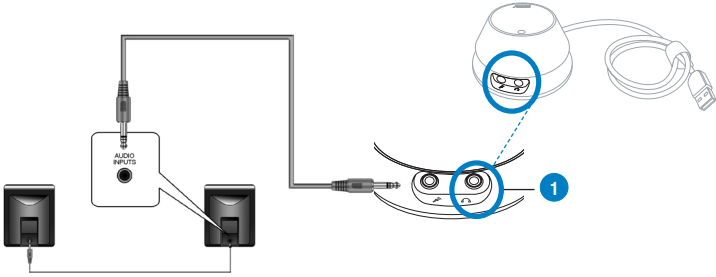

#### 2.1 Speakers

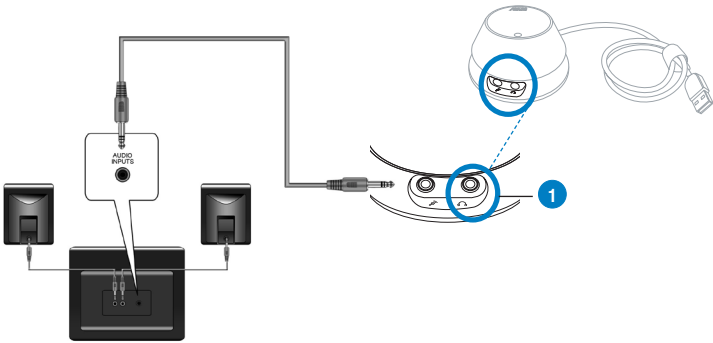

No	Item	Description
1	Headphone Jack	Connect the 2/2.1 speaker set's 3.5mm plug into this Headphone jack.



## 5.3 Connecting Microphone

### Connecting headphone / microphone

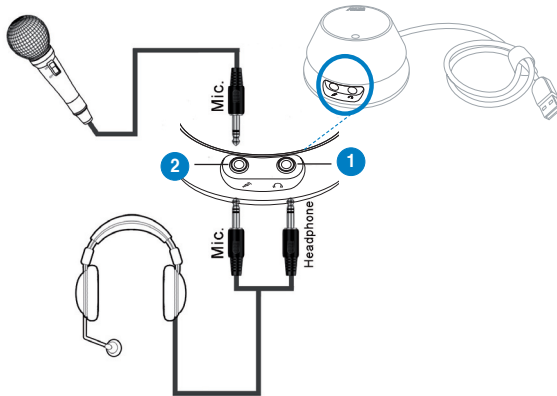

No	Item	Description
1	Headphone Jack	Connect your headphone directly to this jack.
2	Microphone Input Jack	Connect the microphone's 3.5mm plug into this Mic-In jack for voice communication, recording, or karaoke.

## 5.4 Connecting Line-In Audio Sources

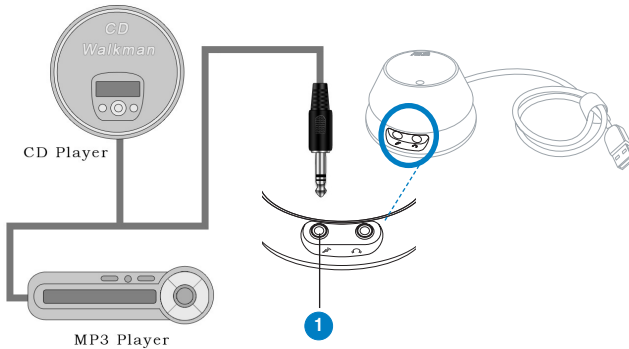

No	Item	Description
1	Line Input/Microphone Jack	Connect the 3.5mm plug of the CD/MP3 Player or any other Line level analog audio sources into this Line-In/Microphone jack for sound recording or real-time Dolby sound processing through the Monitoring path (See the "Mixer" section of the driver guide).

# 6. Xonar U1 Driver Guide

## 6.1 Introduction to the Xonar U1 Audio Center GUI

1. After the driver installation is complete and your computer has been rebooted, you will find the Xonar U1 Audio Center's icon in the system tray on the bottom right-hand corner of the screen. Double click this icon to open the Xonar Audio Center utility.



If the icon could not be found in the system tray, go to the Windows Control Panel and double click the "Xonar U1 Audio Center" icon.

2. The Xonar U1 Audio Center is the Graphic User Interface (GUI) for the Xonar U1 driver. You can control the functions and features of the Xonar U1 driver on the Audio Center. The following picture shows a basic overview of the Xonar U1 Audio Center. The following sections of this manual will describe its functions in more detail.



No	Item	Description
1	Display Area	This display area shows the 10-band signal meter, volume level, and the status of the Dolby technology, EQ, and DSP modes. Note: this area just displays information, but is not used to alter settings.
2	Menu Open/Close	Clicking this button will move the display area and reveal the configuration area below. Clicking it again will move the display area back down.
3	Master Volume	This rotary knob controls the master playback volume. Drag the small circle inside it to change the volume level.
4	SVN Button	Click this button to enable the "Smart Volume Normalization" feature for constant volume from all playback sources. It will display a blue light when enabled.
5	Mute Button	Click this button to mute audio playback; it will display a red light when playback is muted.
6	DSP Mode	These 4 buttons give access to quick sound effects combinations for Music, Games, DVD Video, and effect-free (Hi-Fi) modes.
7	Setting Menu Panel	This panel gives access to setting tabs, including Main Settings, Mixer/volume, Effects, Karaoke/MagicVoice, and Array Mic. (see the following details)
8	Information icon	Clicking this icon will pop up driver's Information window.

## 6.2 Main Setting

### 6.2.1 Sample Rate

The Sample rate determines the number of audio samples per second that the Digital-to-Analog Converters (DAC) and S/PDIF digital interface will output. The Xonar U1 audio card can support sample rates up to 48KHz. Even if your setting differs from the audio source's sample rate, the Xonar U1 engine will do super high fidelity sample-rate-conversion with a double floating-point filter.



No	Item	Description
1	Sample Rate	The Xonar U1 supports sample rates up to 48KHz.

## 6.2.2 Analog Out/Speaker Test



No	Item	Description
1	Analog Out	The Analog Out setting is used to match your actual speaker setting, such as headphones, 2 speakers (or 2.1). Xonar U1 will play the channels and does the proper 3D/Dolby sound processing accordingly. Select the correct speaker/ Headphone type for your connected speakers/ Headphone.
2	Speaker Test	Click this button to show the speaker test window in the right pane. Click the "play" button to test each speaker one by one or click each speaker manually to test.  (note: the Speaker Test function is not available on Windows Vista due to a limitation in its audio stack.)

### 6.2.3 SPDIF Out/DDL

Xonar U1 is capable of outputting Dolby Digital Live, which are real-time encoders that transcode any audio, including games and music, into industry-standard Dolby Digital bit-streams on-the-fly. This is ideal for playback through a home theater system, creating an immersive and impressive cinema surround sound experience. It enables a single digital connection to carry high quality Dolby Digital surround audio from your PC to digital speakers and AV Receivers.

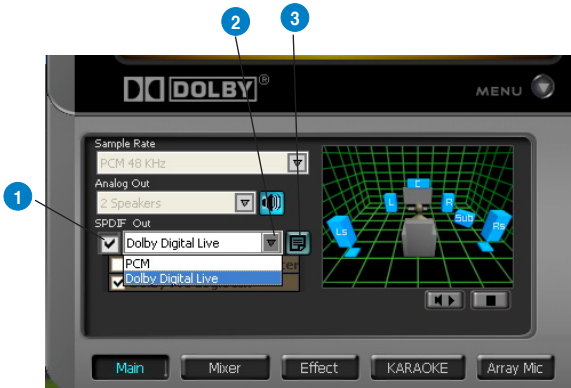

No	Item	Description
1	S/PDIF Out enable/disable	Click this check box to enable S/PDIF output.
2	S/PDIF Output Formats/Functions	This pull-down menu allows you to select one of the following two formats: -PCM (Pulse Code Modulation, which is a typical raw audio data format.) -Dolby Digital Live real-time 5.1ch encoding
3	Dolby Digital Live advanced upmixing option	This advanced setting will automatically upmix stereo (2ch) content to 5.1 channel surround with Dolby Pro-Logic IIx when using Dolby Digital Live output.

## 6.2.4 Audio Channels (For Vista only)

This setting only appears in Windows Vista. Vista will deliver the audio channels to the audio driver according to this setting, no matter what the original audio content is or how many channels they have. Therefore, you need to set this in accordance with your audio content before you play it. Please note that this setting is synchronized with Vista's system speaker configuration and changing the setting during playback will cease the audio playback program. You may have to restart the program after the change. It's recommended that you close all playing programs before you change the setting.



No	Item	Description
1	Audio Channels	Here are some typical suggestions: -MP3, WMA, AAC, CD, VCD, 2D games => 2 channels -DVD-Video with Dolby Digital or DTS 5.1 => 6 channels -DVD-Video with Dolby Digital EX or DTS ES => 8 channels -3D games => 8 channels

## 6.2.5 7.1 Virtual Speaker Shifter

The 7.1 Virtual Speaker Shifter has the following major features:

- Expanding/upmixing audio to 7.1-channel surround sound
- Virtualizing 7.1 surround sound over any set of speakers
- Shiftable virtual speaker positioning allows you to adjust the best sound field easily without moving physical speakers and wires

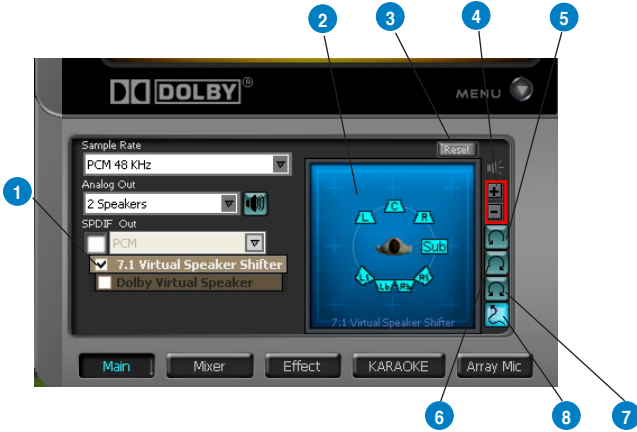

No	Item	Description
1	Shifter enable/disable	Click this check box to enable the 7.1 Virtual Speaker Shifter. Clicking the text bar will switch the right window to the Speaker Shifter page for manual adjustments.
2	Drag speaker or listener	You can drag each speaker or listener to a different relative position "virtually" using only your mouse. The Xonar U1 audio station will process it and virtualize each speaker position in real-time. The Subwoofer has no directional sounds, and hence can be moved only closer or further away.
3	Reset	Reset all Speaker Shifter settings to the defaults.
4	Increase/decrease volume	Click + to increase volume (move speakers closer); click - to decrease volume (move speakers further away)
5	Counter-clockwise	Make all speakers (except Subwoofer) rotate counter-clockwise
6	Clockwise	Make all speakers (except Subwoofer) rotate clockwise
7	Manual Rotation	Manually drag and rotate all speakers (except Subwoofer)
8	Manual Drag Mode	This is the default mode that allows you to manually drag each speaker or the listener with your mouse.



## 6.2.6 Dolby Pro-Logic IIx

Dolby Pro-Logic IIx is a 7.1 surround upmixing technology and is widely used in home theater systems, TVs, game consoles, and car audio systems. It can expand stereo audio, such as MP3, CD, and TV programs into immersive 5.1 or 7.1-channel surround.

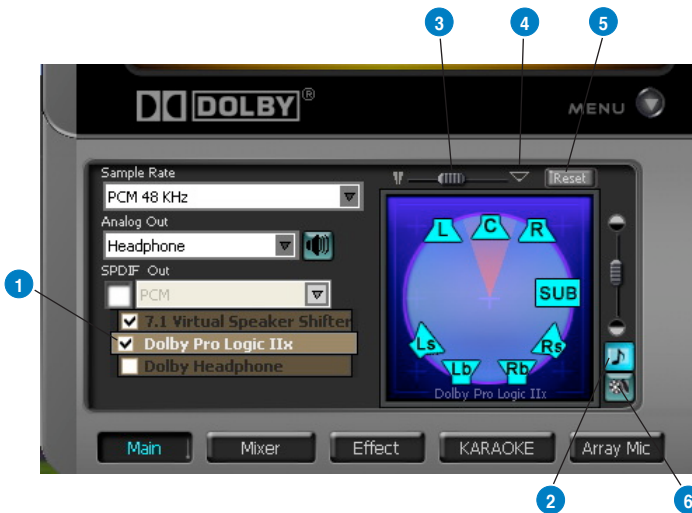

No	Item	Description
1	Dolby Pro-Logic IIx enable/disable	Click this check box to enable Dolby Pro-Logic IIx. Clicking the text bar will switch the right window to the Pro-Logic IIx page for manual adjustments.
2	Music Mode	Music mode is the default mode for regular music playback. In this mode, you can adjust the Center Width and Dimension parameters.
3	Center Width	This parameter is used to set the spread of the center, mainly for the vocal signals of songs and music. Drag the scroll bar to the left to centralize the vocal signal. Drag to the right side to widen the vocal sound range.
4	Dimension	The dimension parameter fades sounds to the front or rear of the listener.
5	Reset	Reset all settings to the defaults.
6	Movie Mode	Movie mode is a preset optimized for movie audio.

## 6.2.7 Dolby Headphone

Dolby Headphone creates a stunning multi-channel surround experience over ordinary stereo headphones for playing 3D games, watching 5.1 DVD movies, and listening to music. Dolby Headphone produces surround sound cues so realistic that you will believe you are listening over speakers in a well-controlled studio. Dolby Headphone can also improve listening comfort and reduce "listener fatigue" from long listening over headphones.





No	Item	Description
1	Dolby Headphone enable/disable	Click this check box to enable Dolby Headphone. Clicking the text bar will switch the right window to Dolby Headphone page for manual adjusting.
2	DH1	Dolby Headphone (DH) provides three room filters that may be used with any type of audio. They differ in the sense of the “spatial dimension” they impart.  DH1—Reference Room: Small, acoustically damped room.
3	DH2	DH2—Livelier Room: More acoustically live than DH1
4	DH3	DH3—Larger Room: Larger room than DH1; more distant and diffused effect.

## 6.2.8 Dolby Virtual Speaker

Dolby Virtual Speaker technology simulates a 5.1-speaker surround sound listening environment from as few as two speakers. Dolby Virtual Speaker also creates a wider two-channel environment during playback of stereo CDs and MP3 content, and when combined with Dolby Pro Logic® IIx processing, delivers a virtual 5.1-channel surround listening experience from any high-quality stereo source.



No	Item	Description
1	Dolby Virtual Speaker enable/disable	Click this check box to enable Dolby Virtual Speaker. Clicking the text bar will switch the right window to a Dolby Virtual Speaker page for manual adjusting.
2	Reference Mode	Dolby Virtual Speaker provides two modes of virtualization: The first is Reference mode, which virtualizes the missing speakers as in the following picture. 
3	Wide Mode	Wide mode virtualizes the necessary speakers and enhances the surround experience as in the following picture. 

## 6.3 Mixer/Volume

The mixer page is designed to control the volume for playback and recording on the Xonar U1. In addition, the Xonar U1 also provides a high-quality digital monitoring function for hearing the recorded audio from the speakers. You can also process the input signals with all playback sound effects such as Dolby technology.

### 6.3.1 Playback Volume



No	Item	Description
1	Playback Volume Tab	Click this button tto show the playback volume page.
2	Source/Path Name	This shows the source name for each volume control slider, including: <ul style="list-style-type: none"> <li>- WAVE: All digital audio sources except MIDI files</li> <li>- SW: Software Synthesizer; control the playback volume of the MIDI files</li> <li>- CD: CD-ROM digital playback (CD-DA) volume control</li> <li>- LEFT, RIGHT...: the volume control for each speaker/channel.</li> </ul> Note: Windows® Vista doesn't support WAVE, Synthesizer and CD-In volume controls.
3	Mute/Unmute button	Click this button to mute or unmute the audio channel.
4	Volume Slider	Drag this slider down to decrease the volume; drag it up to increase the volume. The tool-tip reveals the percentage number from 1 to 100 in terms of the full scale level.
5	Left/Right Balance	The horizontal slider controls the volume between the left and right channels.
6	Reset	Reset all volume controls to the default settings

### 6.3.2 Recording/Monitoring Volume



No	Item	Description
1	<b>Recording Volume Tab</b>	Click this button to show the recording volume page.
2	<b>Source/Path Name</b>	This shows the source name for each volume control slider, including: MIC: recording from microphone Line-In: recording from Line-in jack for external audio devices WAVE: recording from digital wave audio you are playing on PC (Note: Windows Vista doesn't support WAVE recording.)
3	<b>Monitoring button</b>	Click this button to monitor and loopback recording audio to outputs (PC speakers). Therefore, the recording volume will influence the monitoring signals from speaker outputs. The audio will be mixed into the streams you are playing out from your PC and all DSP effects will be applied to the source, too. A typical benefit is to apply Dolby Pro-Logic IIx 7.1-ch spreading for your TV audio, CD, MP3, or stereo game console audio from Wii, Xbox, PS2/PS3/PSP, etc. To apply Dolby Virtual Speaker is suitable for two-speaker environment.
4	<b>Recording Selector button</b>	Click this button to select the path/source you are going to record. Please note that the recording function on Windows is a one-path selector. So, you can select only one default recording source at a time. You may have to restart the recorder program if you switch to a different source. (Note: On Vista, some application programs may allow you to select the recording device/path in the recording programs themselves.)

5	<b>Recording Volume Slider</b>	Drag this slider down to decrease the recording volume; drag up to increase the recording volume. The tool-tip reveals the percentage number from 1 to 100 in terms of the full scale level.
6	<b>Left/Right Balance</b>	This horizontal slider controls the volume between the left and right channels.
7	<b>Reset</b>	Reset all volume controls to the default settings

## 6.4 Effects

### 6.4.1 Environment Effects

Environment effects can be used to create realistic listening experiences that mimic different environments. There are a total of 27 environment options, which can be applied to all 2D sound sources, like music.



No	Item	Description
1	Default Environments	These four buttons activate Bathroom, Concert hall, Underwater, and Music Pub environments, respectively.
2	More Option	Clicking this button will apply the environment effect that you select from the pull-down menu on the right side. There are another 23 options in this menu.
3	Environment Size	There are three size settings for each environment: Large, Medium, and Small.

### 6.4.2 10-Band Equalizer

The equalizer can modify the audio output for different frequencies, and be used to compensate for deficiencies in your speakers/systems. There are 12 default patterns and you can also make your own settings.

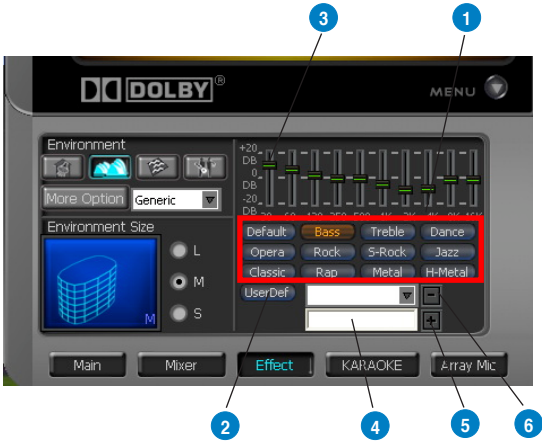

No	Item	Description
1	Default Equalizer Options	There are 12 available equalizer patterns. Click one to apply it.
2	User Defined	You can click this button to apply your own defined parameters saved in the pull-down menu.
3	Equalier Slider	Adjust the gain for each band (30~16KHz)
4	Save Name	Key in a name for your own "User Defined" equalizer setting
5	Add/Save	Click this + button to save the parameters into User Defined list
6	Delete	Click this - button to delete the parameters from User Defined list



## 6.5 Karaoke/Magic Voice

The Xonar U1 provides powerful features for VOIP and Karaoke, including Magic Voice, Microphone Echo, Key-Shifting, and Vocal Cancellation. Magic Voice is a great feature for disguising your voice (using monster/cartoon/male/female effects) for VOIP and online gaming applications. Microphone Echo can generate natural echo effects on your singing voice just like a karaoke machine. Key-Shifting can change the pitch of Karaoke background music, and Vocal Cancellation can reduce the original vocal in songs and keep the music and symphony for karaoke.



Microphone Echo and Magic voice features are not available on Windows Vista.



No	Item	Description
1	On/Off	The switch to turn on or off the functions on this page.
2	Mic Effect On/Off	Check the box to enable or disable mic effects including Microphone Echo for voice or Magic Voice for changing your voice's sound.
3	Mic Echo	Select the Mic Echo function and adjust the gain for echo signals (30~16KHz)
4	Magic Voice	Select Magic Voice and choose a mode from 5 options: default, Monster, Cartoon, Male, and Female styles.
5	Key-Shifting	Check the box to enable or disable the key shifting feature for music playback from 4 semitones below, to 4 semitones above.
6	Key-Shifting	Checkbox to enable or disable the vocal cancellation function and adjust the voice cancellation level from 0 to +100. +100 will eliminate most original vocals (default value is 50).
7	Reset	Reset all settings to the default.

## 6.6 Mic Array

It can reduce environmental background sounds and noises as well as keeping your front side voice input as clean as possible.



No	Item	Description
1	On/Off	Check the box to enable or disable array microphone.

## 6.7 Smart Volume Normalization

Smart Volume Normalization™ (SVN) automatically keeps all music or video/TV audio output at a constant level to reduce manual adjustment hassles inherent with sound sources of different loudness. It allows you to listen to various content, like MP3, TV program, DVD video and even games with consistent sound level. The following graph shows how different signals 1 & 2 will become the same level (for example, 10dB below full scale) after you turn on SVN. Please note that for lower volume music 2, it will become louder when you turn on SVN; and for higher volume music 1, it will become quieter.

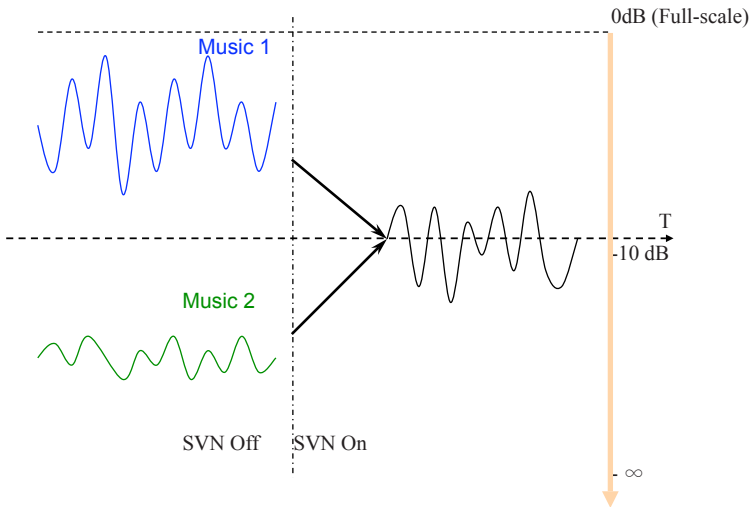



No	Item	Description
1	SVN On/Off	Click this button to enable SVN. This button is outlined blue when active.
2	SVN Display	When SVN is enabled, "Smart Volume" will be lit up at the bottom of the volume meter and the volume meter will show the level.
3	SVN Blue Light	When SVN is enabled, the master volume knob will be illuminated by a blue light. It will be lit red if the volume is muted.

## 6.8 DSP Modes

Besides the abundant sound effects described above, the Xonar U1 also provides quick Digital Sound Processing modes which are configured for typical applications including Music, Movies, and Games over different output speaker types. In addition, Xonar U1 also offers a Hi-Fi mode for hi-fidelity playback without any effect processing to keep the original audio fidelity. Every time you turn on Hi-Fi mode, Xonar U1 will clear all sound effects. It's also recommended to use Hi-Fi mode for audio quality tests (using RMAA software or another machine-based measurement). Use the DSP mode button as the quick setup if you don't wish to know the details of the effect setup.



No	Item	Description
1	Music Mode	This mode is set for Music playback.
2	Movie Mode	This mode is set for DVD Movie playback.
3	Game Mode	This mode is set for Games.
4	Hi-Fi Mode	This mode is set for Hi-Fidelity playback, where all effects will be cleared to keep the original digital data and analog output quality as high as possible.

# 7. Portable Music Processor™ Lite Software Guide

## 7.1 Introduction

Xonar U1 provides the Portable Music Processor™ Lite (referred to as PMP Lite hereafter) software tool that contains the following features:

- Converts MP3, WMA, Audio CD, WAVE into WMA or MP3 files with the same ID3 information and post processor effects
- Adds Dolby Headphone processing to regular music content for a better listening experience over stereo headphones
- Adds Dolby Virtual Speaker (w/ Pro-Logic II) effect to regular music for virtual 5.1 surround over stereo speakers
- Normalizes the volume level of your music collection with Smart Volume Normalization (SVN) effect
- Supports MP3 and WMA encoding formats for 128~320Kbps data rates (Windows Media Player 9 or later version and MP3, WMA codecs are required)
- Supports transformation speed up to a maximum of 40 times of the normal playback speed (High Speed mode). (The maximum speed is just for your reference because it's related to your PC's performance and the sound effects you choose to add.

Before you use PMP Lite software, make sure the following items have been completed:

1. Xonar U1 Audio Station has been installed in your PC
2. The Xonar U1 driver has been installed (Xonar U1 audio converter driver is installed for PMP Lite utility)
3. You will also need an MP3 encoder installed to encode music into MP3 format (If you don't have this already, the Xonar U1 installer will provide a guide message to download a free MP3 encoder)

After PMP Lite is installed, you will find a PMP Lite shortcut icon on the desktop. Double click the icon and PMP Lite will show up as below.

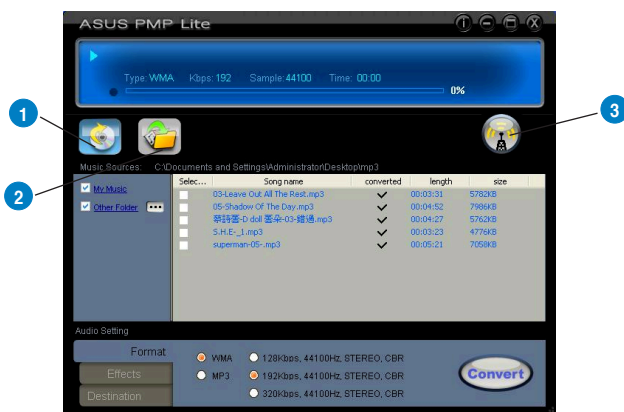

No	Item	Description
1	Main Setting page	Default page to setup and start the music conversion
2	PMP Music page	This page will display the converted music files saved in the "PMP Music" folder
3	Software Update	This button is used to check online for upgrades to the PMP software and download it for upgrade (make sure your computer is connected to the Internet before you click the button)

## 7.2 Converting music in “Main Setting” Page

Click the main setting page to start the PMP Lite music conversion process.



No	Item	Description
1	Select Music Sources	<p>Step 1 is to prepare the music sources that you are going to convert. You can select 2 music source folders which can be multiply checked:</p> <p>1) My Music – This path is locked and refers to C:\Documents and Settings\My Documents\My Music.</p> <p>2) Others – The default path refers to C:\Documents and Settings\My Documents\My Music but can be designated to other folder by clicking .</p> <p>In the right side of the window, you will see all of the music files from the selected folders that can be converted by PMP Lite. You can select all or click each check box to choose which file to be converted later. The files that have been converted during the process will show a check mark in the status column.</p>



2	Conversion settings	<p>Step 2 is to set the conversion settings you would like. There are three tabs for different settings:</p> <p>1) <b>Format:</b> select MP3 or WMA to be the converted format you would like to have. You can also choose the bitrate from 128Kbps, 192Kbps, and 320Kbps (the higher bitrate, the higher quality but bigger file size)</p> <p>2) <b>Effect:</b> You can choose to add three effects into the converted files: Smart Volume Normalization (to normalize all volume of your music files to a constant level), Dolby Headphone (natural spatial effect for headphones), and Dolby Virtual Speaker (with Pro-Logic II virtual surround effect for stereo speakers).</p> <p>3) <b>Destination:</b> This tab allows you to choose to save converted music to the default PMP Music folder, or to Other folder by clicking .</p>
3	Convert/Stop	<p>The final step is to click the button to start Converting. Clicking this button again while PMP Lite is converting files will stop the process. Please note that the audio card will suspend operation while PMP Lite is converting music to ensure conversion quality and stability. It's best to close other audio applications before you start converting.</p>
4	Display for converting status	<p>This display window will tell you the music being converted, file type, bitrate, spent time, converted percentage, and speed.</p>
5	Information page	<p>Clicking the information button will display the version of PMP Lite that you have installed.</p>

### 7.3 Find Converted Music in “PMP Music” Page

The default conversion destination folder is C:\Program Files\ASUS PMP Lite\PMP Music\. You can easily click the PMP Music page to find the converted music library. The new file name will be copied and suffixed with the data rate and DH (ie. Dolby Headphone) or DVS (ie. Dolby Virtual Speaker) if the effect is applied. For example:

Original file name: ABCD.mp3

Converted file name: ABCD\_192K\_DH.mp3 (meaning the data rate is 192Kbps with Dolby Headphone post-processing applied)

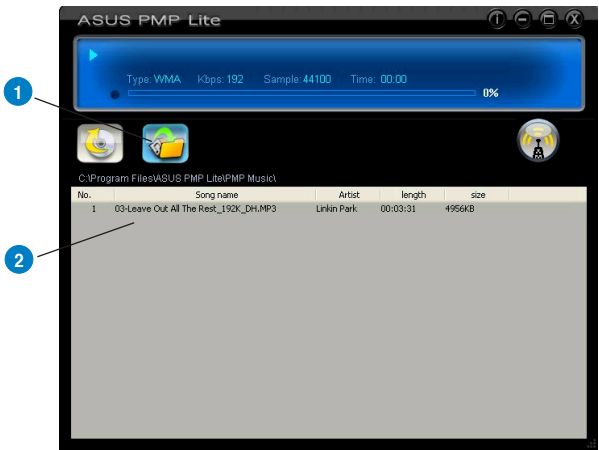

No	Item	Description
1	PMP Music page	This page shows the converted music library stored in the PMP Music folder.
2	Music Information	This window will display the song name and its artist, length, and size in the PMP Music folder.

## 8. Troubleshooting and FAQs

### [Troubleshooting]

#### **The Xonar U1 driver could not be installed on my PC.**

##### **Instructions:**

1. Make sure that you have plugged the Xonar U1 into USB port.
2. Check that the Windows hardware device manager has discovered a USB audio device. If no device is found, try scanning for new hardware or restart Windows.
3. Remove the Xonar U1, plug it into another USB port, and try again.

#### **The PMP Lite software could not be installed on my PC.**

##### **Instructions:**

Check the following points:

1. The Xonar U1 has been installed in your PC.
2. The Xonar U1 driver has been installed successfully.
3. Windows Media Player Ver. 9 or above has been installed in your PC
4. PMP Lite will also need an MP3 encoder installed to encode music into MP3 format (If you don't have it yet, the PMP Lite installer will provide a guide message to download a free MP3 encoder)

#### **I couldn't find the Xonar U1 Audio Center**

##### **Instructions:**

1. Make sure you have installed the driver
2. Find the Xonar U1 Audio Center icon in the system tray on the bottom right-hand corner of the screen. Double click the icon to open the Xonar U1 Audio Center utility.



3. If the icon could not be found in the system tray, go to the Windows Control Panel and double click the "Xonar U1 Audio Center" icon to make it visible in the system tray again.
4. After the driver installation is complete, it's recommended that you reboot your computer to complete the setup. If the icon still doesn't appear, please try installing the driver package again.

## **I can't hear any sound from my analog speakers**

### **Instructions:**

1. Make sure that you have connected speakers properly and have powered on your speakers
2. Make sure that the device master volume or the software player has NOT been muted on the Xonar U1 Audio Center.
3. If you are using Dolby Digital Live encoder through the S/PDIF output, the analog output will be muted to get rid of the interference between your digital speaker system and analog speakers or headphones. Please check if this is the case.
4. Try restart your Windows.

## **I can't hear any sound from the S/PDIF output**

### **Instructions:**

1. Ensure that you have enabled S/PDIF output in the Audio Center GUI (Main page)
2. Ensure that you are connecting the correct S/PDIF output jack on the card to the decoder's (AV receiver) S/PDIF input jack.
3. You may need to select the correct input and mode of your decoder or AV receiver. For Dolby Digital Live, you may have to double check that the AV receiver is in that decoding mode.

## **I can't hear audio input (Mic, Line-in, etc.) from my speakers**

### **Instructions:**

1. Go to the mixer recording page in the Audio Center and select the correct input as the recording source if you are using Windows Vista, please also go to system audio control panel to see the current default recording/input device is right.
2. Remember to turn on the digital monitoring button for that recording source.

## Why couldn't PMP Lite convert some music files successfully?

### Instructions:

1. Make sure you have installed Windows Media Player 9 or above version, and MP3 encoder in your PC. (following the pop-up downloading information to finish the installation. To download free MP3 encoder, go to: <http://www.elecard.com/download/#freeware/> )
2. PMP Lite supports MP3, WMA, WAVE, CD source formats.
3. PMP Lite can't support DRM protected content.
4. Currently PMP Lite only support common 16 bit audio sources. If you have 24 bit sources, please try converting it into 16bit formats first with some software editing tool (Ableton Live, Cakewalk, CoolEdit, Soundforge, etc.)

## I cannot hear any audio when I use a 32-bit program to play a DVD movie in a 64-bit version of Windows Vista

### Instructions:

1. This problem may occur if the 32-bit program outputs Sony/Philips Digital Interface Format (S/PDIF) raw data to the audio playback device by using the WaveCyclic miniport driver.
2. For more detail information, refer to <http://support.microsoft.com/kb/936225/en-us>

## Xonar U1 audio center or the driver did not run up when I plugged U1 into the USB port

### Instructions:

1. If you installed a beta driver, you need to make sure you have plugged U1 into the originally connected USB port when you installed the driver. (With a Microsoft WHQL certified driver, Windows will automatically identify U1 device and activate the driver.) Otherwise, install the U1 driver again for the new port. Before you install U1 driver, U1 will still work with Microsoft default USB audio driver for basic playback/recording functions.
2. If you have connected U1 into the right port, go to the **Start menu=> Settings => Control Panel**. Check Xonar U1 Audio Center icon exist and double click it to reload it.
3. Try to unplug and plug U1 again into the same or other USB port and wait a minute for Windows detection and loading driver.
4. If the driver is still not back, keep U1 into the USB port and just re-install the driver package from the Xonar U1 driver CD.

## [FAQ]

### **Q1: Does the Xonar U1 support Windows Vista?**

#### **Answer:**

Yes, the Xonar U1 driver package does support Windows Vista and most key features are available.

### **Q2: Why does the Xonar U1 support Dolby technologies?**

#### **Answer:**

Dolby is the ONLY brand and technologies recognized by the CE industry and available on a wide range of audio equipment. Xonar includes these features to make your PC a powerful media and entertainment center.

### **Q3: Why do I need Dolby for PC games?**

#### **Answer:**

1. Dolby Digital and Pro-Logic IIx are available on the latest game consoles, like XBOX360, PS3, and Wii. Dolby can provide the best gaming sound experience and compatibility with home theater or TV systems.
2. Dolby Headphone and Dolby Virtual Speaker are the best 3D sound positioning, spatial modeling and 5.1-channel virtualization technology for regular stereo headphones and speakers.

### **Q4: Will PCM sound output through S/PDIF be just 2 channels even with different analog output channels?**

#### **Answer:**

The S/PDIF protocol specification (IEC-60958) can only carry 2-channel PCM data or non-PCM AC3/DTS data. So, when a user selects PCM output for S/PDIF, the Xonar U1 will always deliver 2 channel PCM data through the S/PDIF output port. For attaining 5.1 channel surround sounds, you can select Dolby Digital Live encoding output from the S/PDIF out menu, which will allow the Xonar U1 to deliver 5.1 surround sound for games, DVD movies, and even stereo music.